

NeoCaps

— ONE CAPSULE —
INFINITE POSSIBILITIES

Space Capsule Product Catalogue



+995 500 99 98 99

Product Introduction



D-01



D-02



D-03

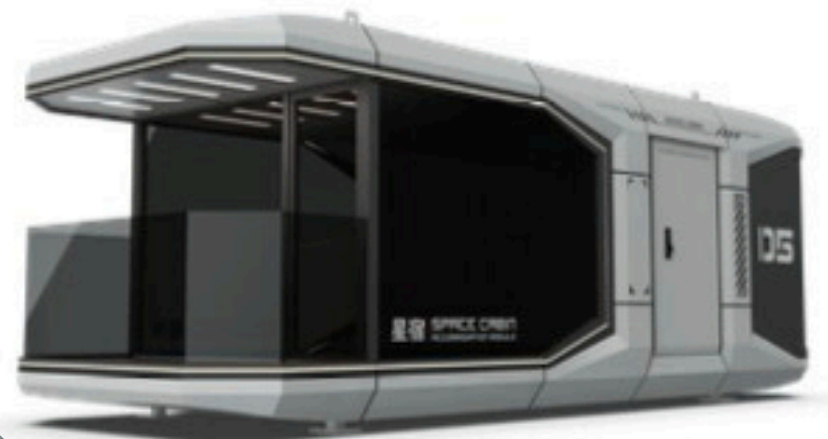

D-05



D-06



D-07



D-08



D-09

Product Introduction



T-05

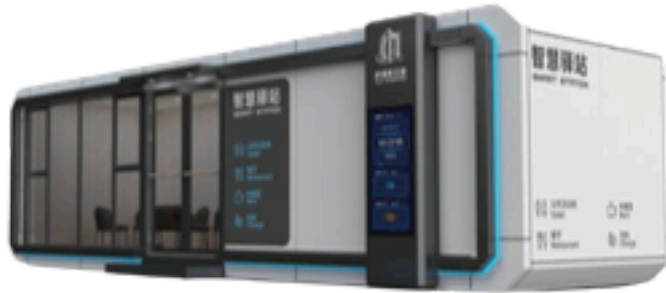

T-06



T-07



T-08



Combined Cabin



S-01



S-02

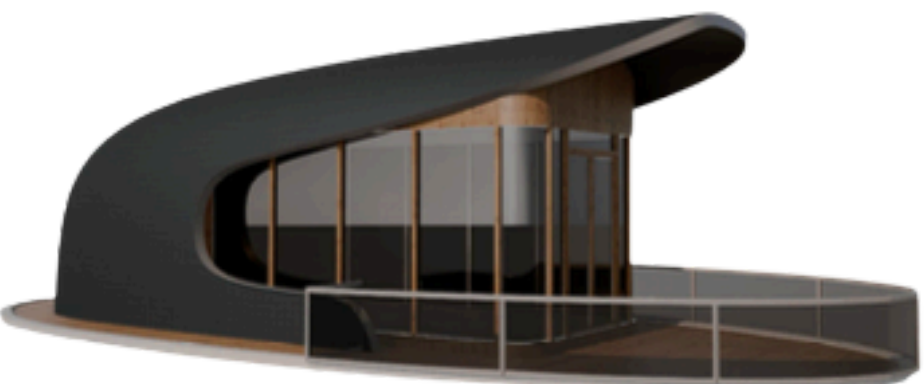

S-03



S-04

D1 Product Details



NeoCaps

— ONE CAPSULE —
INFINITE POSSIBILITIES



D1

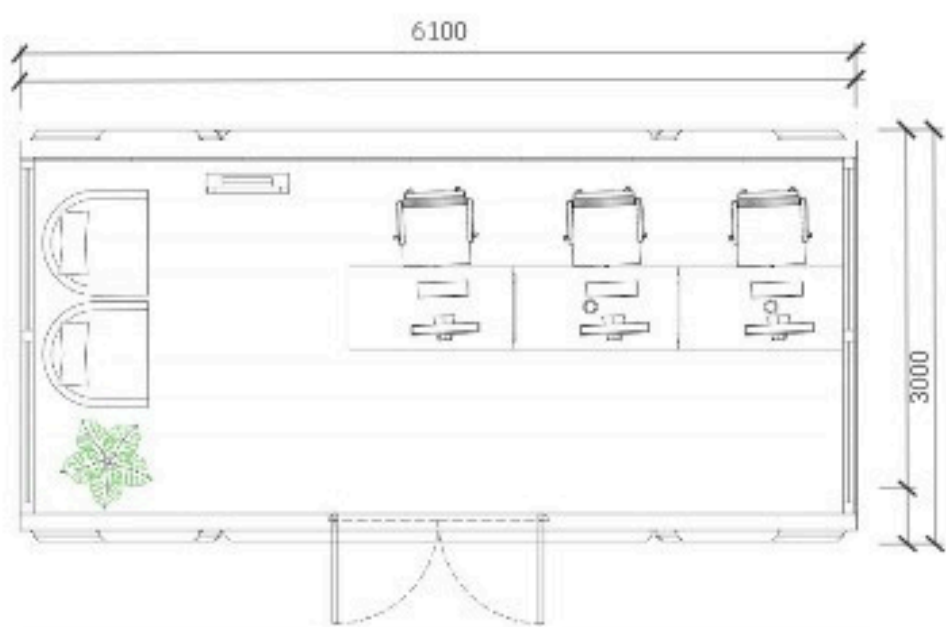

D2 Product Details

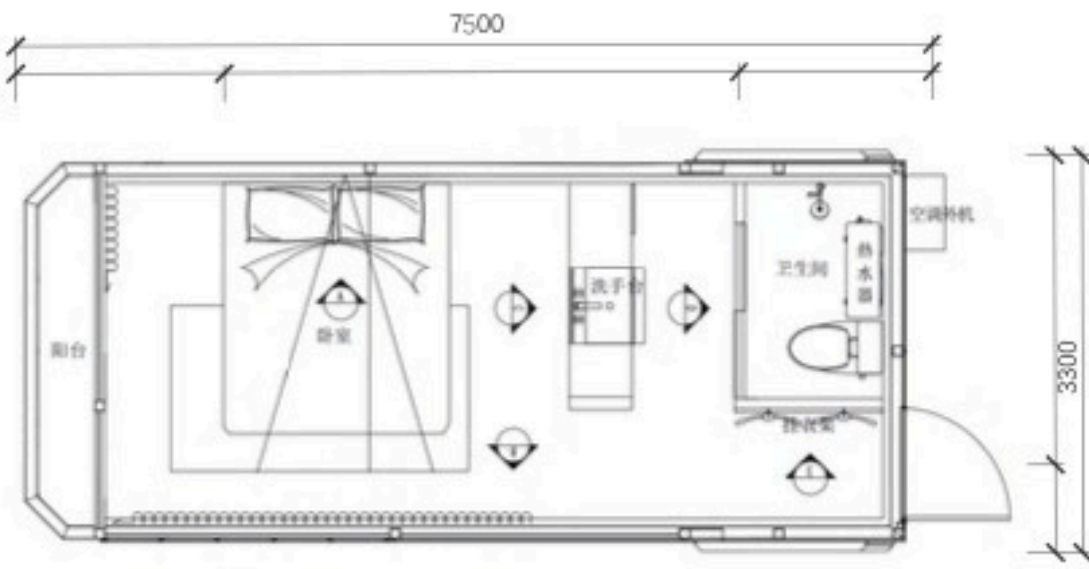

D3 Product Details

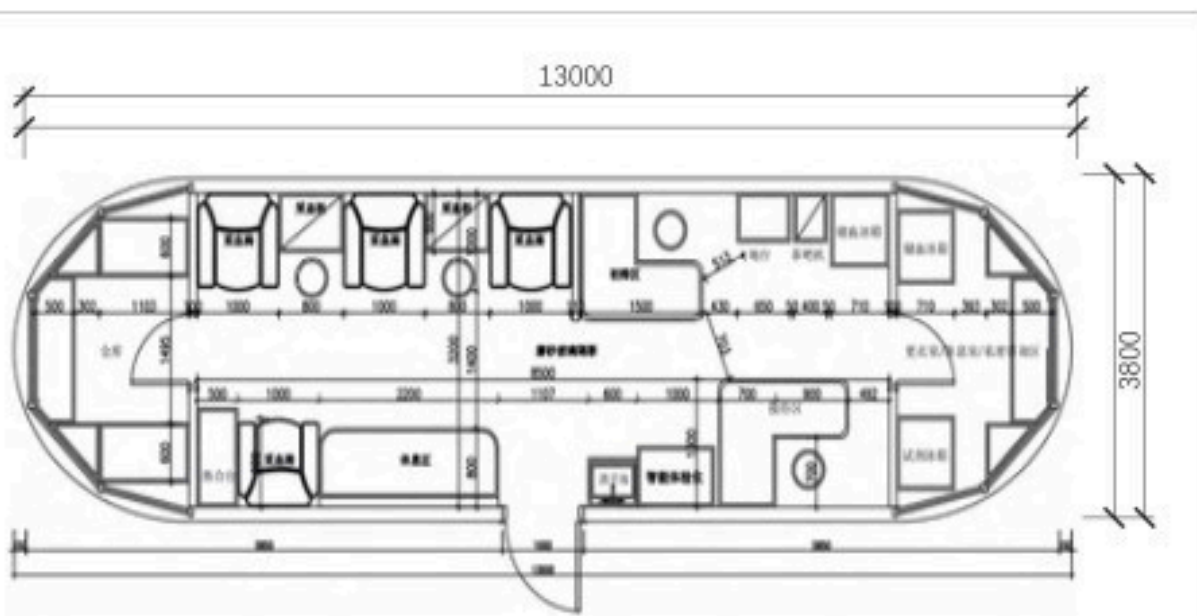

D5 Product Details

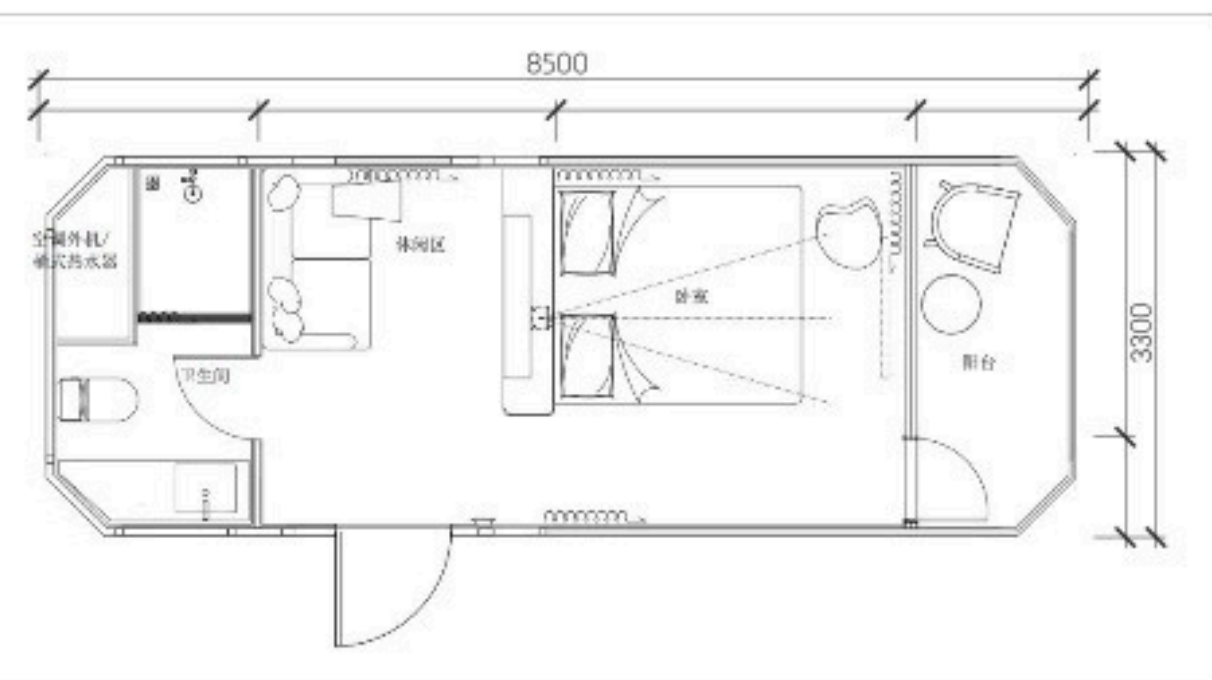
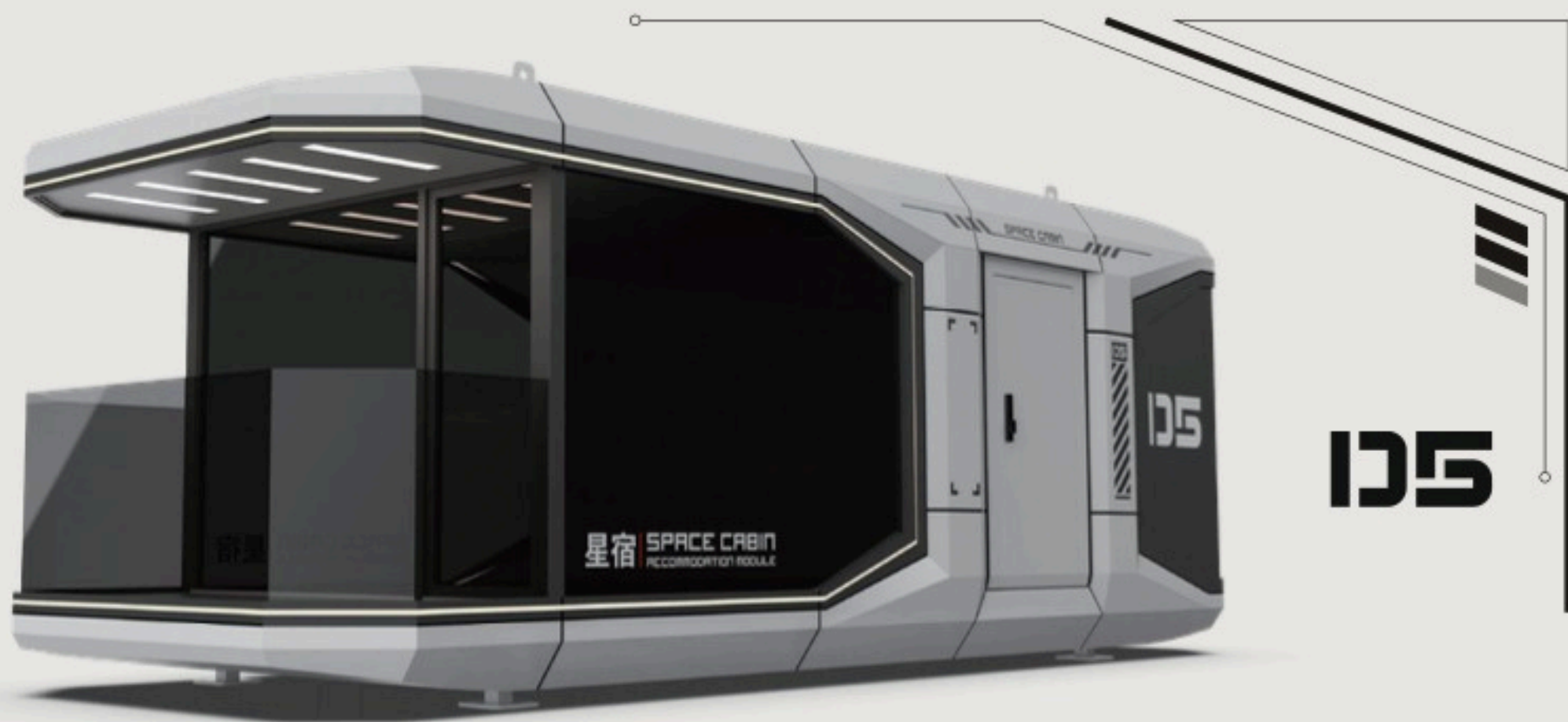

D5 Product Details

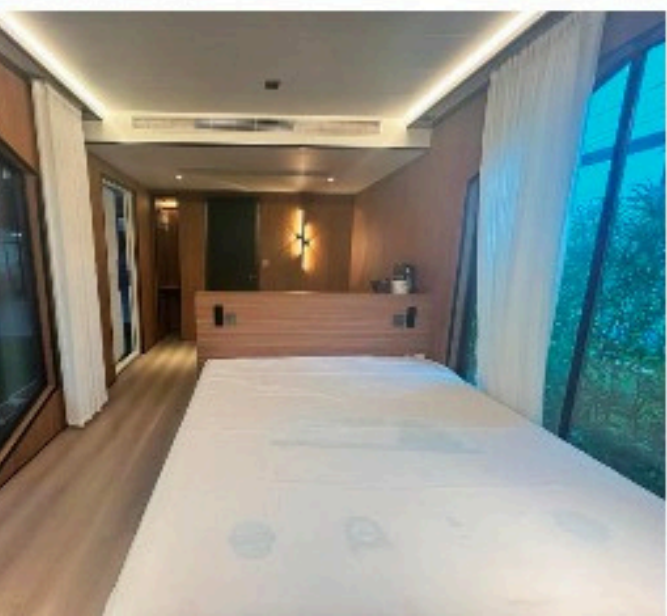

D6 Product Details

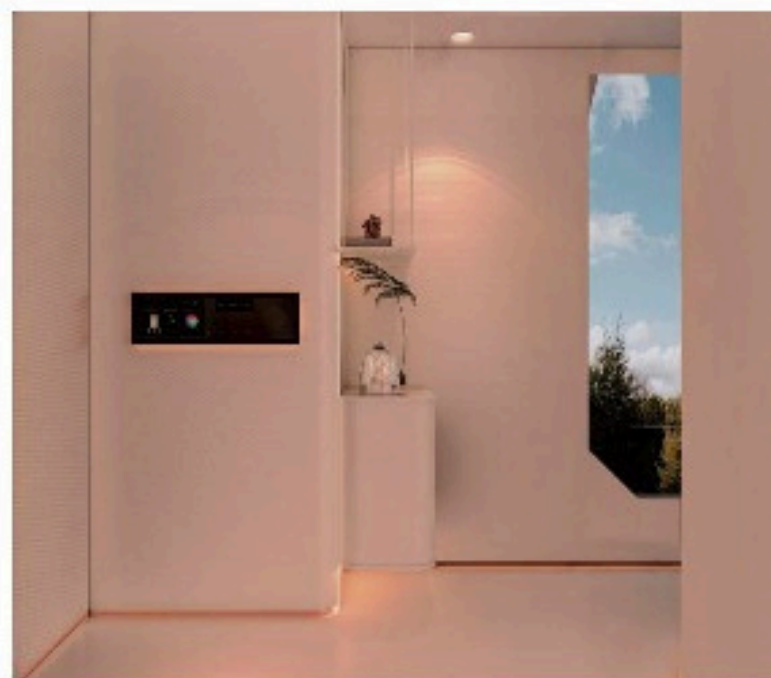
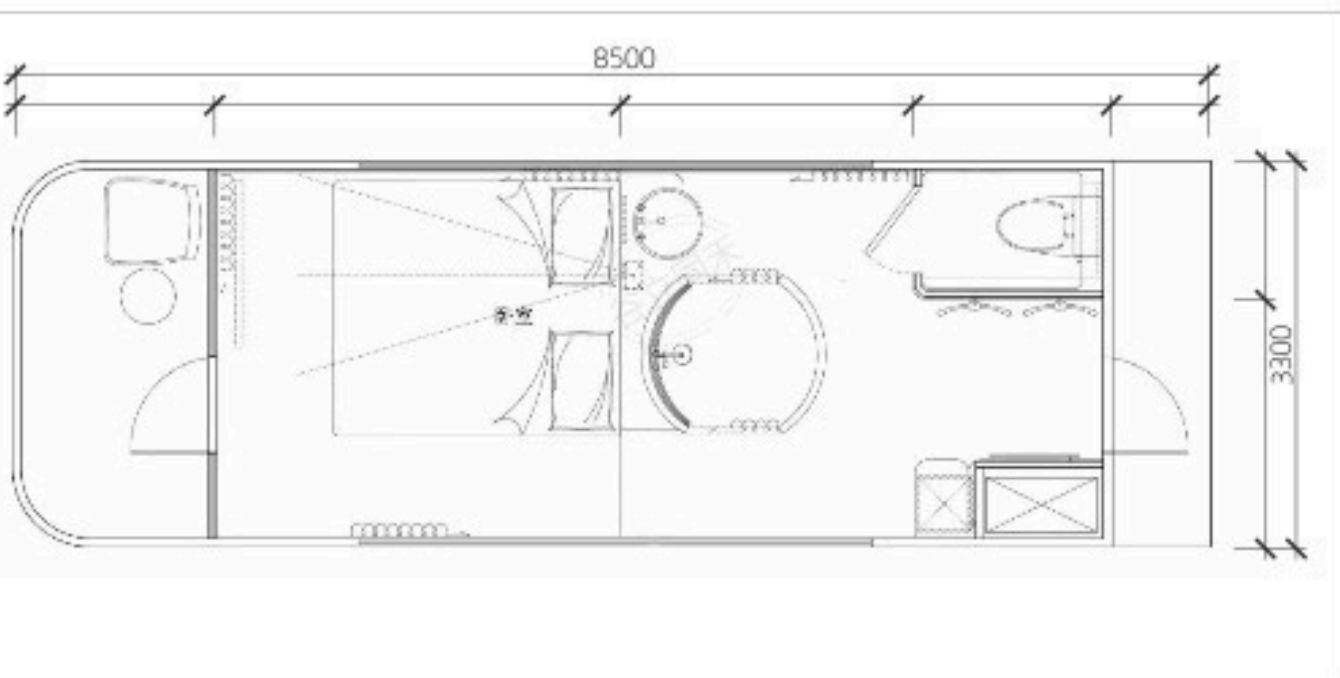

D7 Product Details

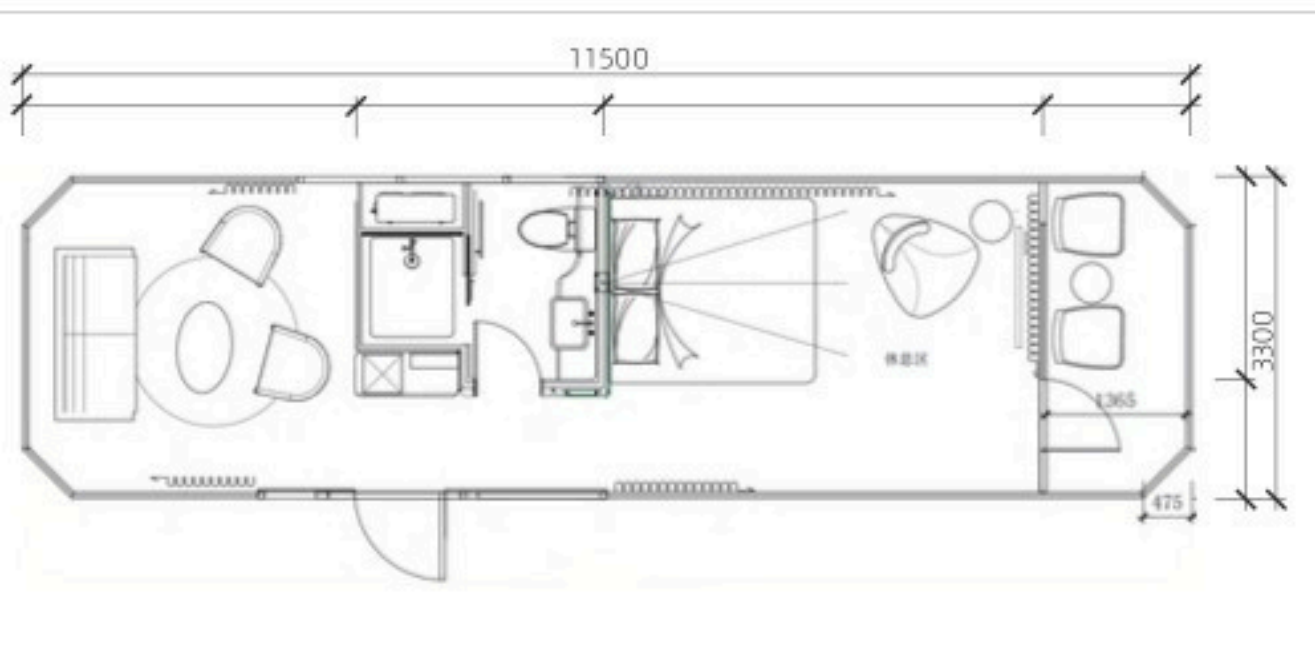
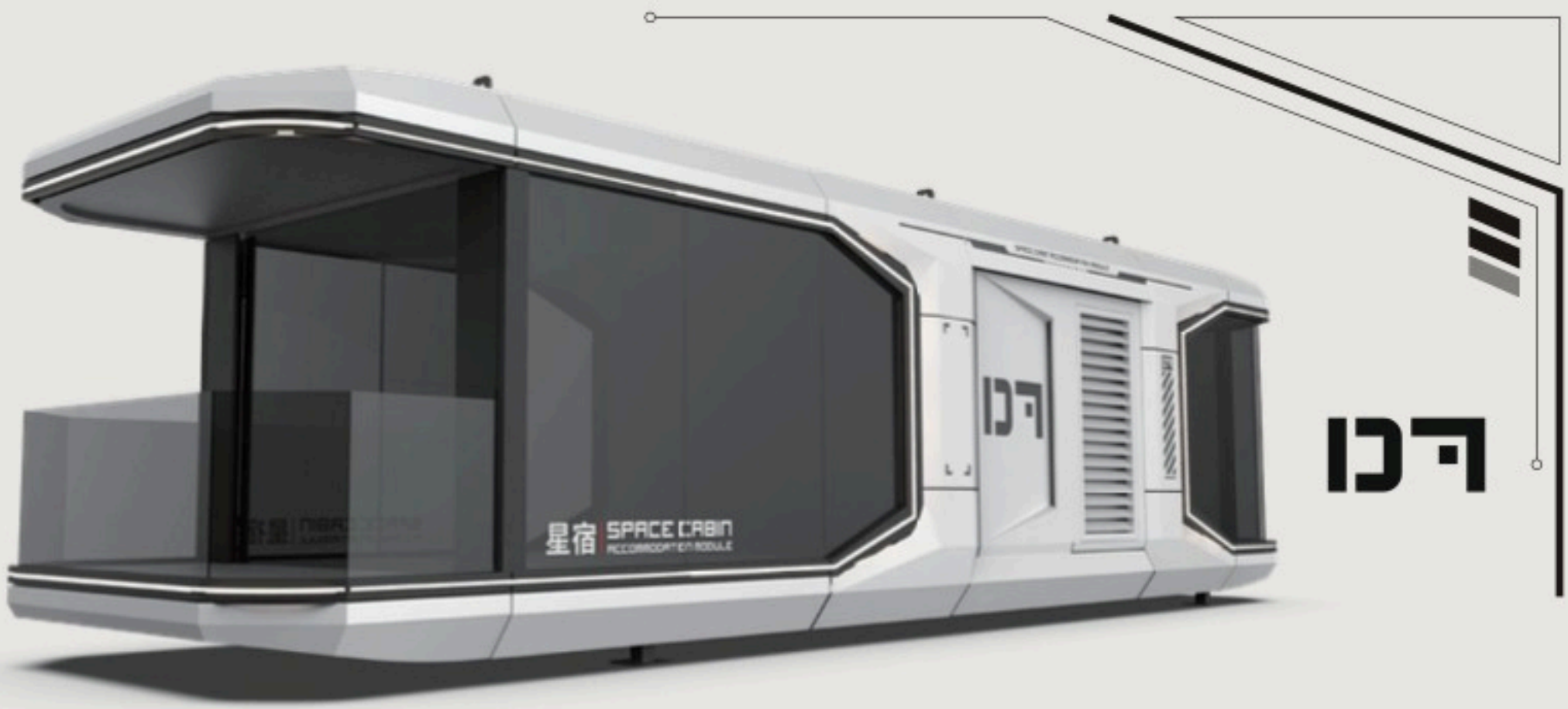

D7 Product Details

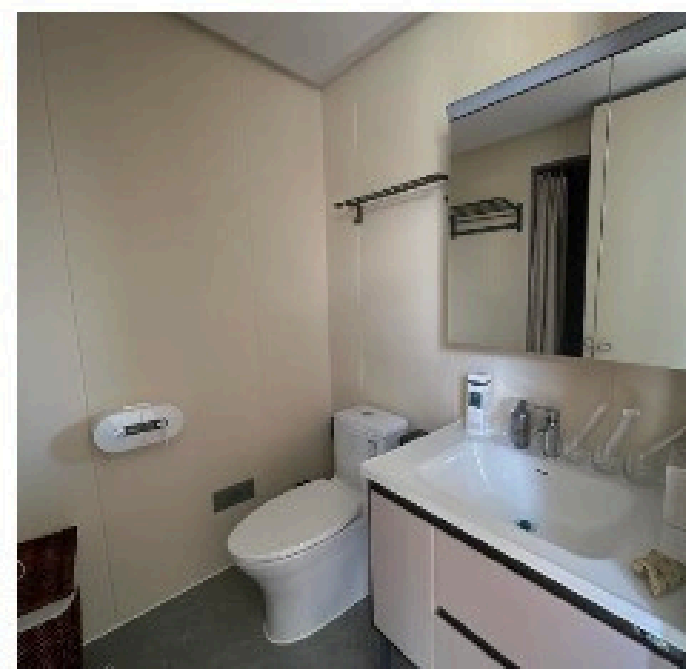
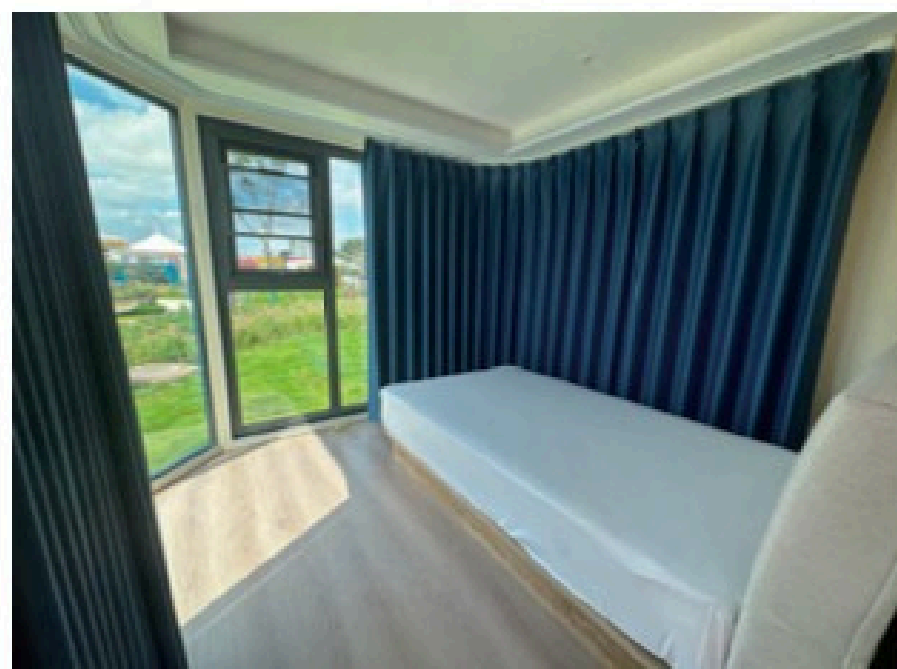

D8 Product Details

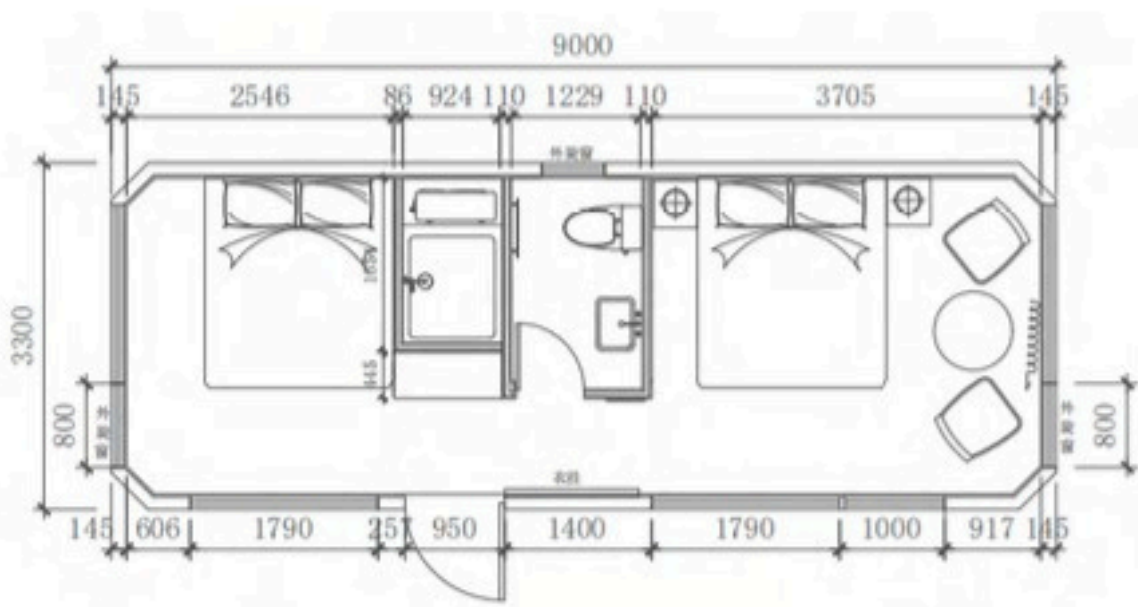

D8 Product Details

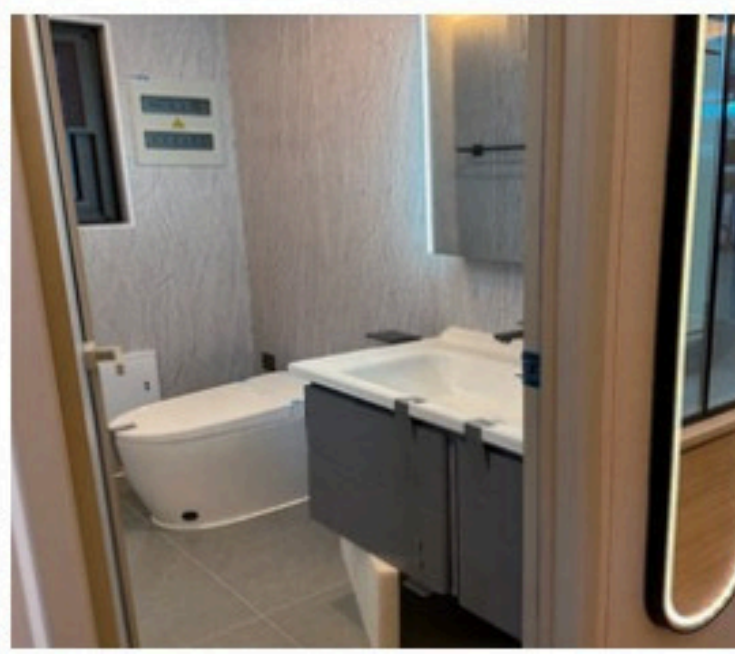
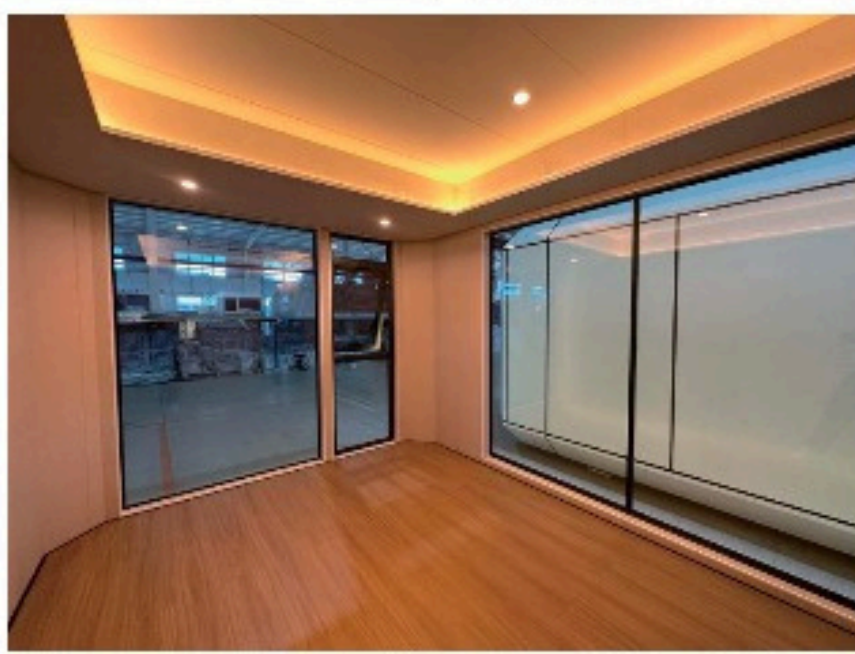

D9 Product Details

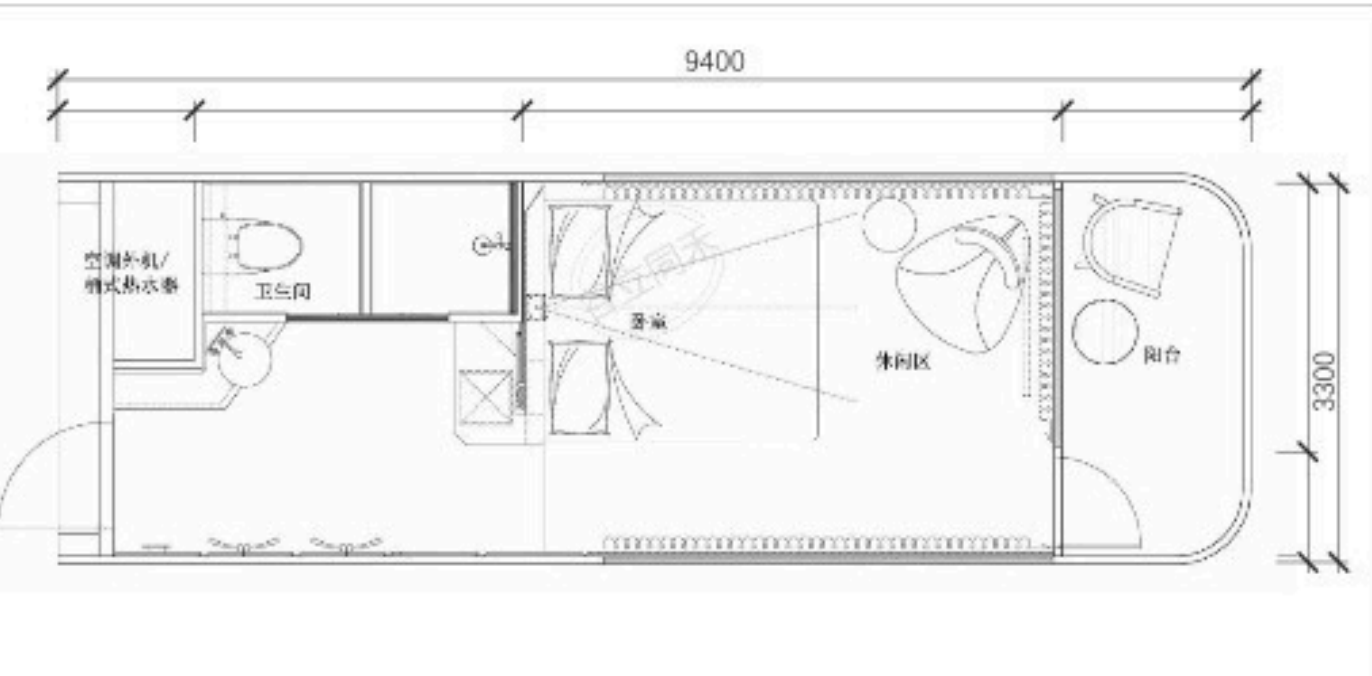

T-05 Product Details

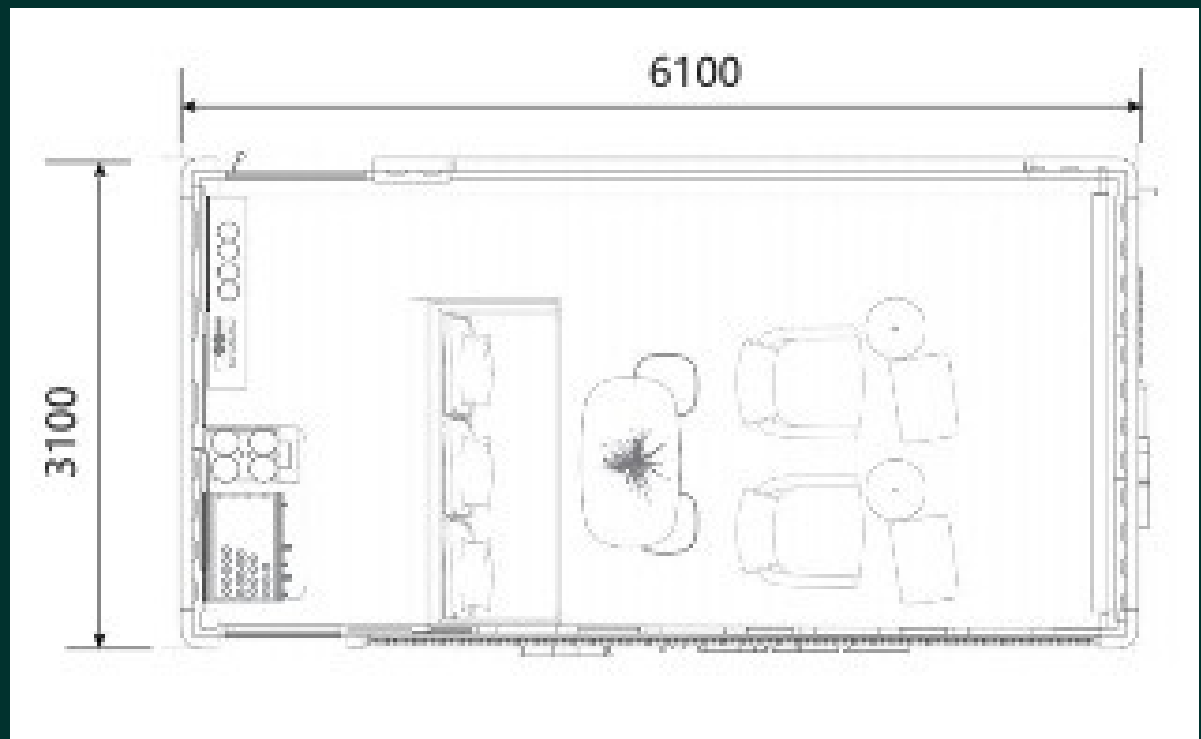

*Product size: 6100*3100*3100mm*



Total Floor Area: 18.9m²



T-06 Product Details

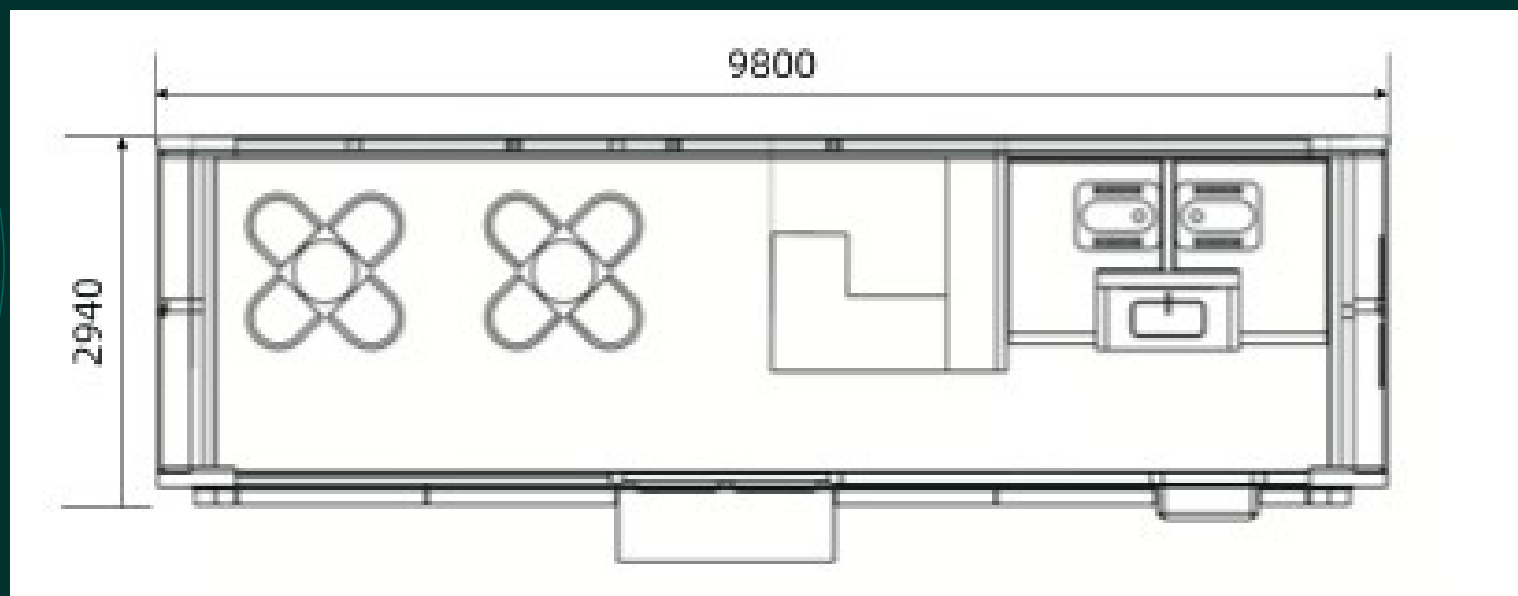

*Product size: 9800*2940*2825mm*



Total Floor Area: 28.8m²



T-08 Product Details

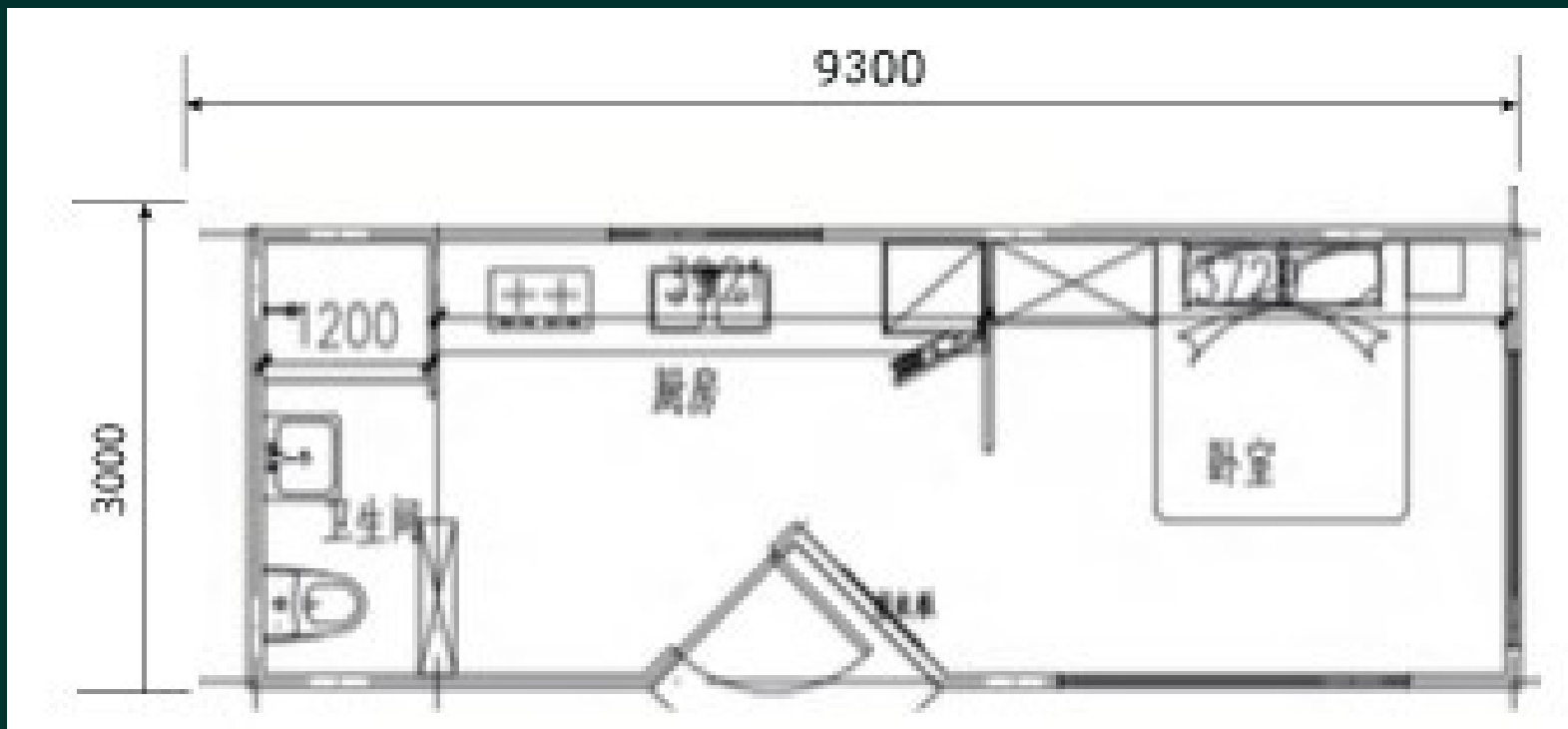

*Product size: 9300*3000*3550mm*



Total Floor Area: 28m²



Combined Cabin

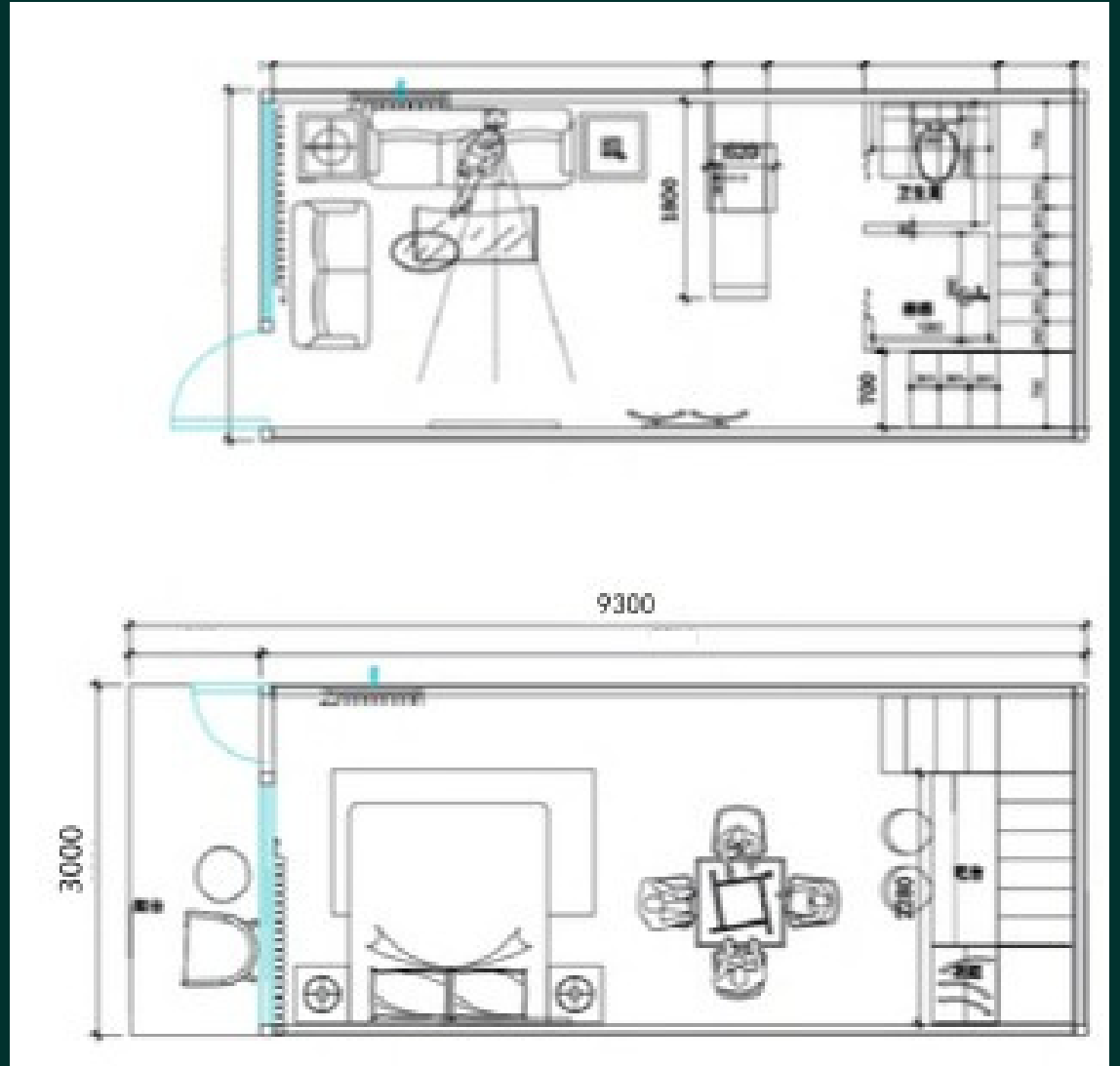

*Product size: 9300*3000*6650mm*



Total Floor Area: 56m²



S1 Product Details

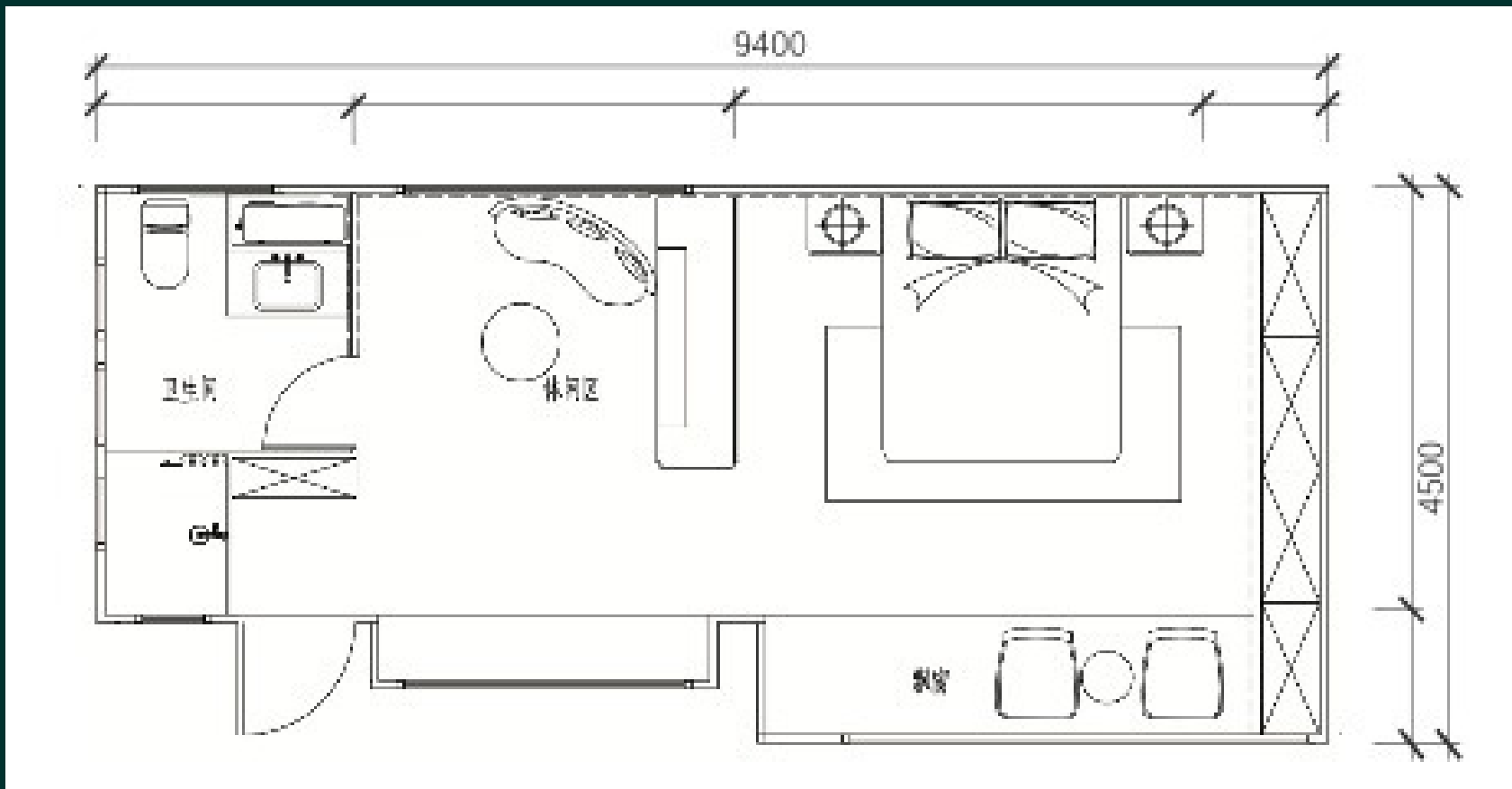

Total Floor Area: 42.3m²



S2 Product Details

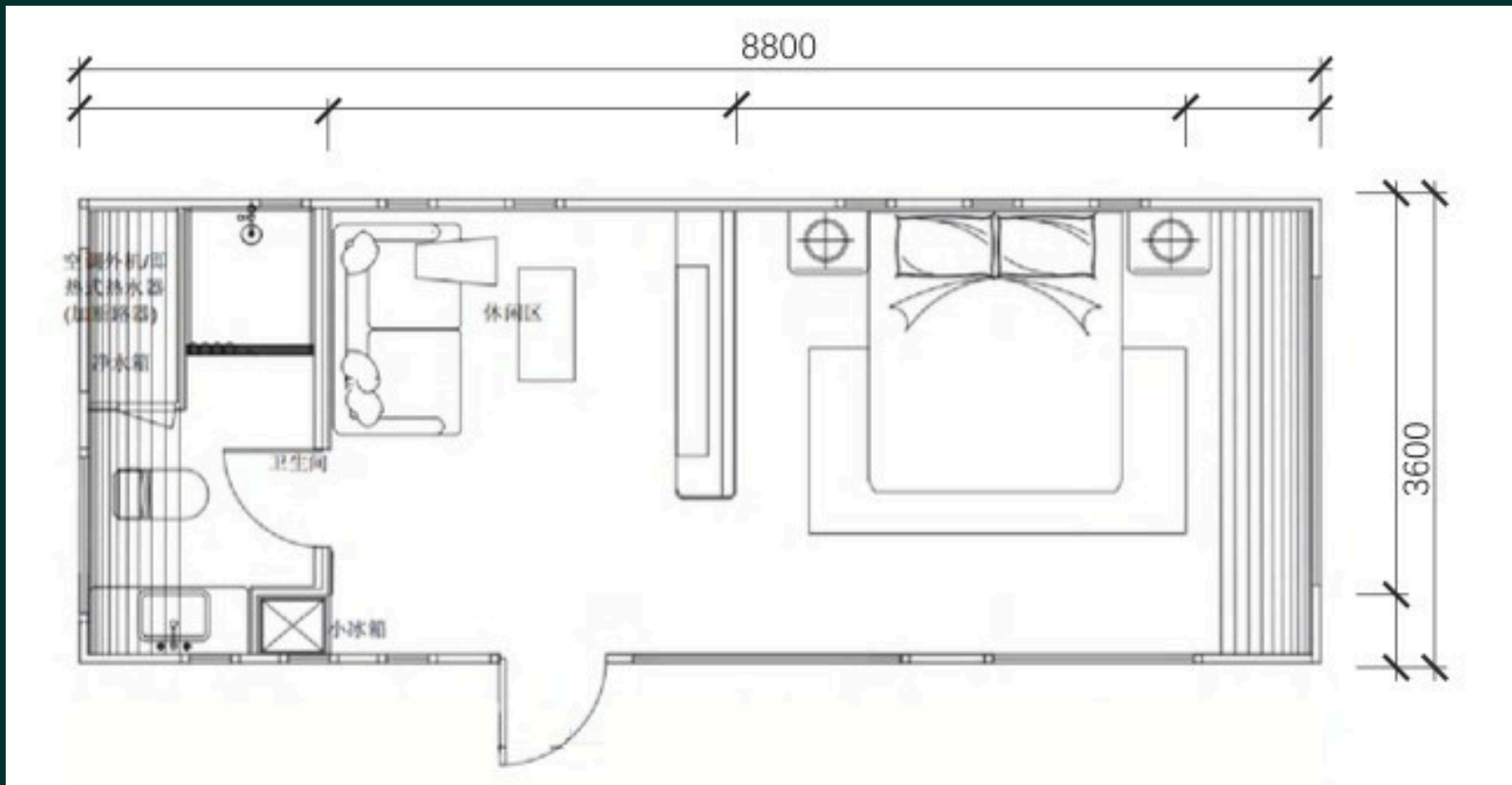

Total Floor Area: 31.6m²



S3 Product Details

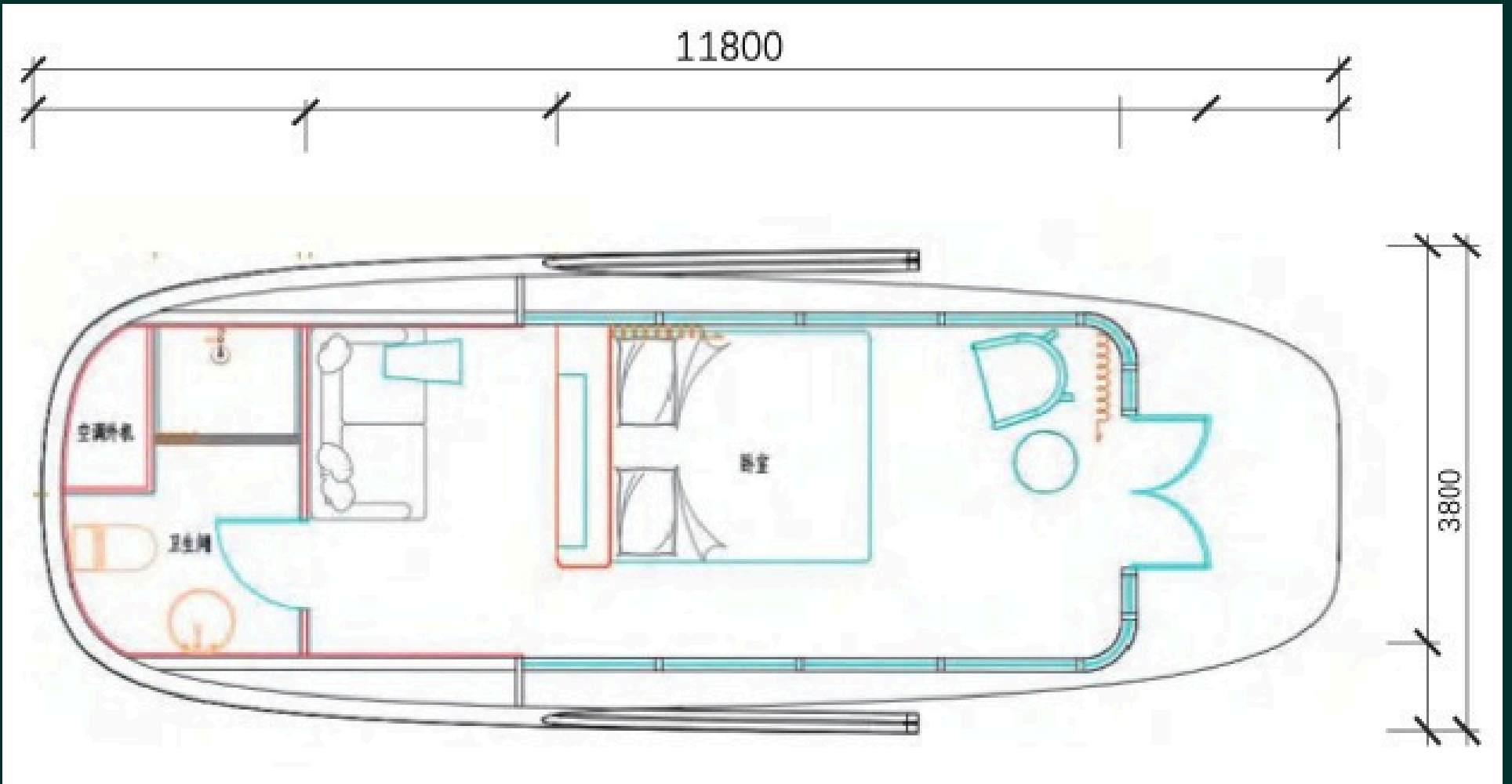

Total Floor Area: 44.8m²

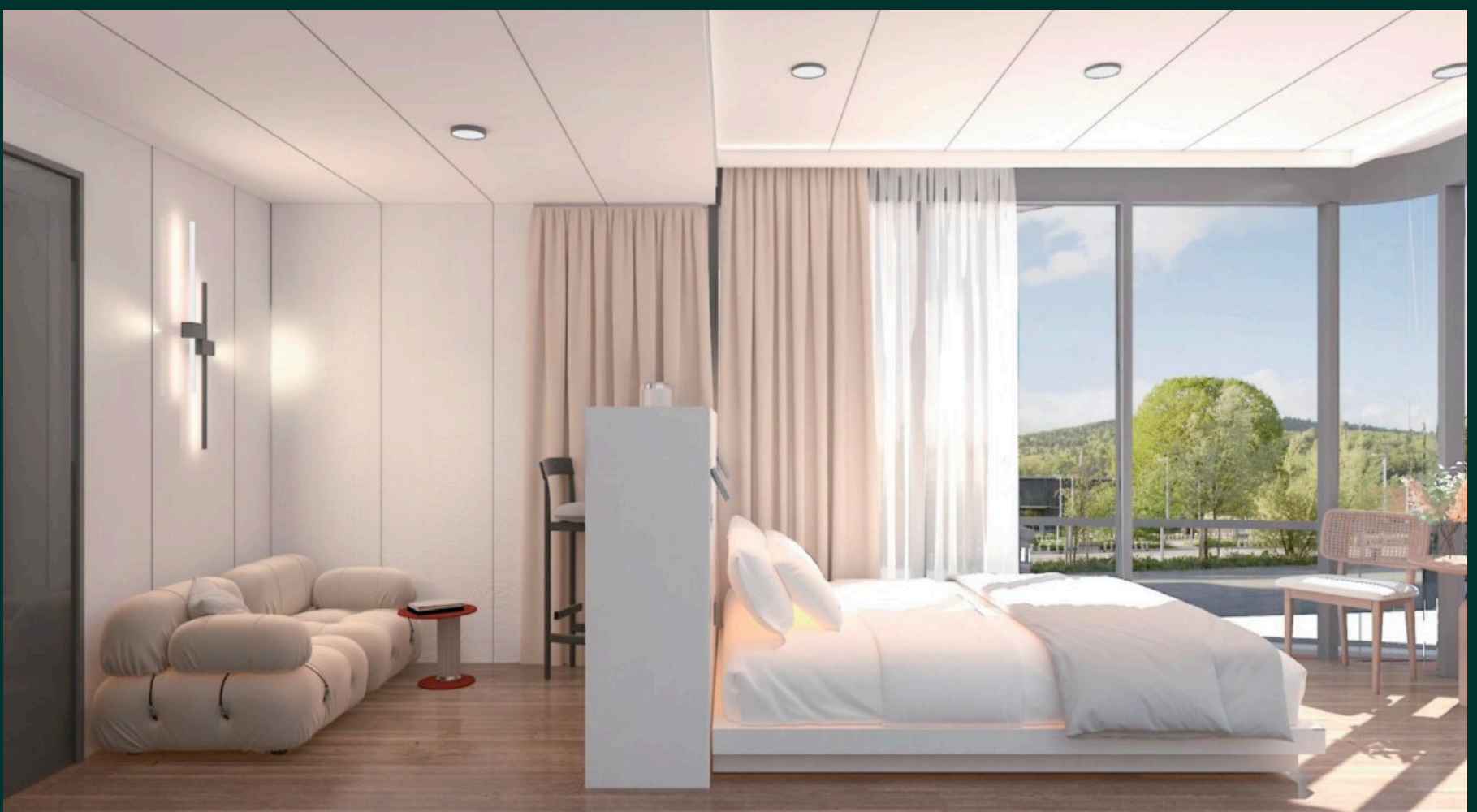

S4 Product Details

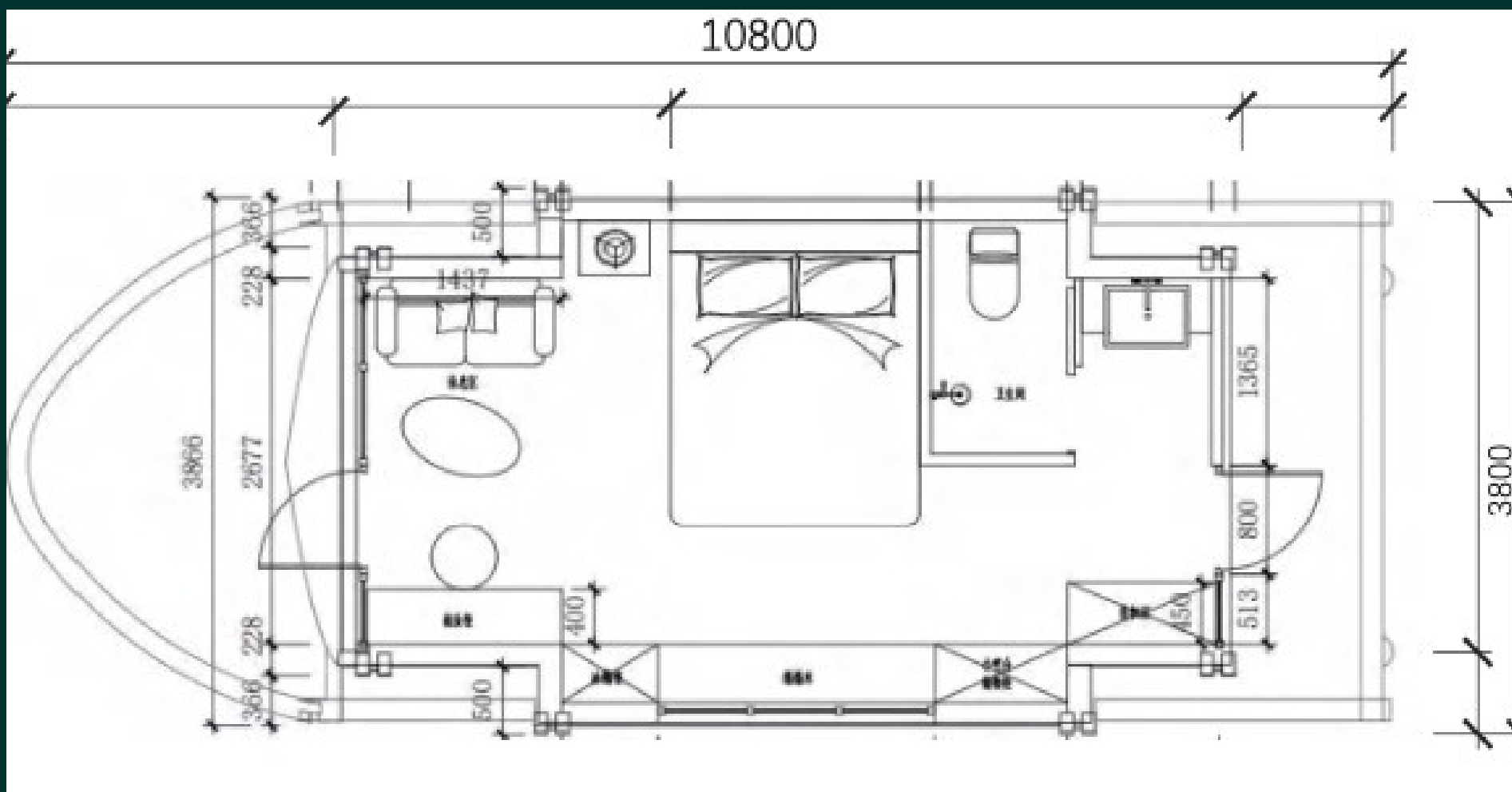

Total Floor Area: 41m²

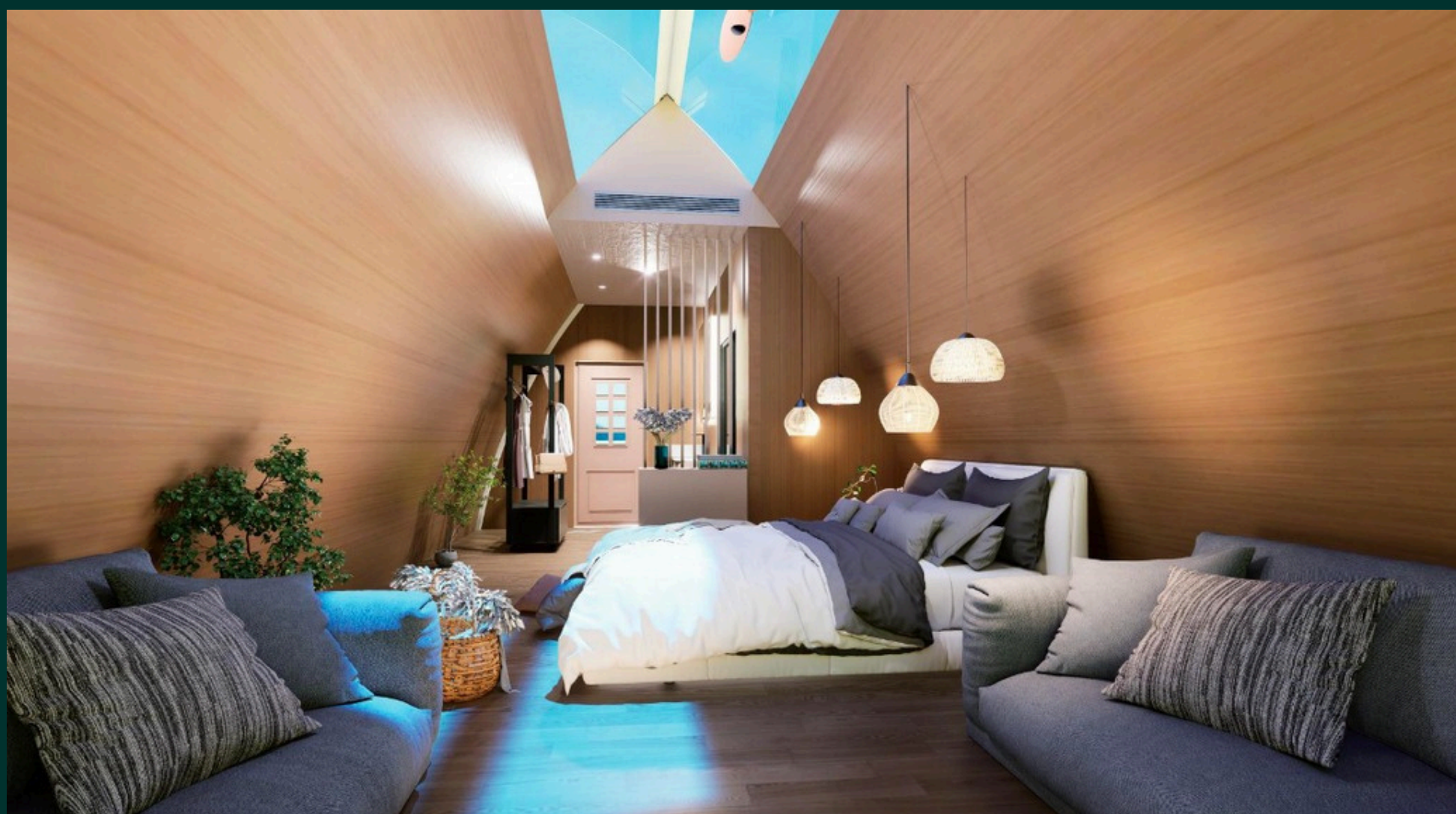

Product Application



Product Application

